



**HAMPDEN FENCE SUPPLY**  
Incorporated

*Proud Craftsmen Skilled in the Manufacturing of Fence Fittings.*

Specializing  
in **QUALITY** Fittings

- Bands • Hinges • Ties •
- Aluminum Fittings •
- Cantilever Rollers with  
5 Year Warranty •



**P.O.BOX 452 • 80 INDUSTRIAL LANE • AGAWAM, MA 01001**  
**(413) 786-4390 • 1-800-891-2235 • Fax (413) 789-3664**

[www.hampdenfence.com](http://www.hampdenfence.com)

[info@hampdenfence.com](mailto:info@hampdenfence.com)

**TERMS OF SALE**

Our terms are 1% discount if paid in 10 days, otherwise net 30 days.  
\$50 Minimum order. 10% Restocking charge.

Powdercoating Available - upcharge for colors other than black.



# INDEX

Backstop Angle, Ductile Iron . . . . .	.9	Gate Hinges	
Barb Arms		Female Gate Hinges, Pressed Steel . . . . .	.11
Barb Arm Bases . . . . .	.9	Male Gate Hinges, Pressed Steel . . . . .	.11
Steel Barb Arm Blades . . . . .	.9	Gate Scrolls, Three Piece . . . . .	.12
Ductile Iron Corner Barb Arms . . . . .	.9	Hinges	
One Piece Barb Arms . . . . .	.9	Bull Dog Hinges, Pressed Steel . . . . .	.15
Brace Bands		Malleable Frame Hinges . . . . .	.10
Beveled Brace Bands . . . . .	.2	Malleable Industrial Box Hinges . . . . .	.15
C Post and H Beam Brace Bands . . . . .	.4	180° Attachment . . . . .	.15
Corner Brace Bands, Beveled . . . . .	.3	Malleable Industrial Offset Hinges . . . . .	.15
Economy Brace Bands . . . . .	.1	Malleable Post Hinges . . . . .	.10
Heavy Brace Bands . . . . .	.5	Hog Rings, Aluminum . . . . .	.6
Square Brace Bands . . . . .	.4	Kennel Bands . . . . .	.16
Two Way Brace Bands, Beveled . . . . .	.3	Locking Devices, Industrial . . . . .	.14
Three Way Brace Bands, Beveled . . . . .	.3	Locking Devices, Residential . . . . .	.14
Cantilever Gate Roller Guards . . . . .	.14	Loop Caps . . . . .	.8
Cantilever Gate Roller Latch Assemblies . . . . .	.13	Nuts and Bolts . . . . .	.18
Cantilever Gate Rollers, Ductile Iron . . . . .	.13	Pliers . . . . .	.20
Cantilever Gate Rollers, Polymer . . . . .	.13	Post Caps, Acorn and Dome . . . . .	.7
Clamps		Rail Ends	
End Rail Clamps . . . . .	.17	Combination Rail Ends, Ductile Iron . . . . .	.8
Kennel Clamps . . . . .	.16	Offset Rail Ends, Aluminum . . . . .	.8
Line Rail Clamps . . . . .	.17	Offset Rail Ends, Pressed Steel . . . . .	.8
Saddle Clamps . . . . .	.16	Tension Bands	
Steel Pipe Clamps . . . . .	.20	Beveled Tension Bands . . . . .	.2
Drive Anchor Units . . . . .	.21	C Post and H Beam Tension Bands . . . . .	.4
Duckbill Gate Holdbacks . . . . .	.15	Economy Tension Bands . . . . .	.1
Fence Ties, Aluminum . . . . .	.6	Heavy Tension Bands . . . . .	.5
Floor Flanges . . . . .	.20	Square Tension Bands . . . . .	.4
Fork Latches, Pressed Steel . . . . .	.11	Tension Bars . . . . .	.18
Frame Clamps, Pressed Steel . . . . .	.12	Top Rail Sleeves . . . . .	.10
Fulcrum Latches, Heavy Duty . . . . .	.19	Truss Rod Tighteners . . . . .	.12
Gate Clips . . . . .	.1	Welded Wire High Security Fence Hardware . . . . .	.22



**B-1 TENSION BANDS - ECONOMY**

Hot Dipped Galvanized 14 Gauge x 3/4" Steel

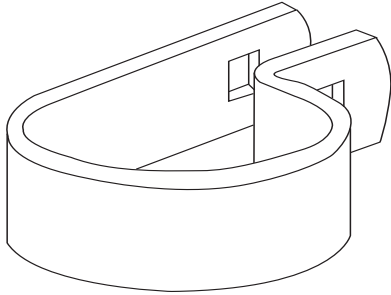

Part No.	Size	Weight	Carton Quantity
TB138E	1 3/8" OD	75 LBS	500
TB158E	1 5/8" OD	78 LBS	500
TB200E	2" OD	68 LBS	400
TB250E	2 1/2" OD	54 LBS	300
TB300E	3" OD	44 LBS	200
USE CARRIAGE BOLTS NB516125 5/16" x 1 1/4"		46 LBS	1000

Available Powder Coated Black

**GATE CLIPS**

Hot Dipped Galvanized 12 Gauge x 5/8" Steel

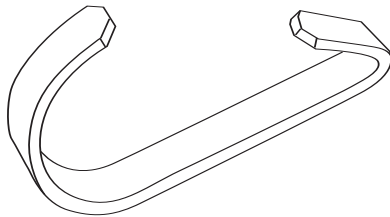

Part No.	Size	Weight	Carton Quantity
GCE	1 3/8" OD	75 LBS	500

Available Powder Coated Black

**B-6 BRACE BANDS - ECONOMY**

Hot Dipped Galvanized 12 Gauge x 3/4" Steel

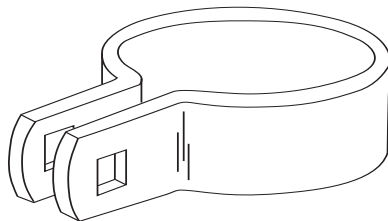

Part No.	Size	Weight	Carton Quantity
BB138E	1 3/8" OD	60 LBS	500
BB158E	1 5/8" OD	64 LBS	400
BB200E	2" OD	54 LBS	300
BB250E	2 1/2" OD	66 LBS	300
BB300E	3" OD	63 LBS	250
USE CARRIAGE BOLTS NB516125 5/16" x 1 1/4"		46 LBS	1000

Available Powder Coated Black



**B-1 TENSION BANDS - BEVELED**  
**Hot Dipped Galvanized 12 Gauge x 13/16" Steel**

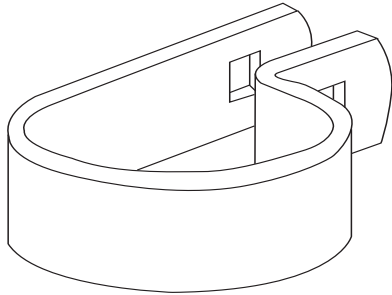

Part No.	Size	Weight	Carton Quantity
TB138B	1 3/8" OD	55 LBS	250
TB158B	1 5/8" OD	58 LBS	250
TB200B	2" OD	50 LBS	200
TB250B	2 1/2" OD	70 LBS	250
TB300B	3" OD	64 LBS	200
TB350B	3 1/2" OD	37 LBS	100
TB400B	4" OD	42 LBS	100
TB450B	4 1/2" OD	45 LBS	100
TB658B	6 5/8" OD	33 LBS	50
TB858B	8 5/8" OD	25 LBS	25
USE CARRIAGE BOLTS			
NB516125	5/16" x 1 1/4"	46 LBS	1000
Also available as special order:			
TB500B	5"		50
TB550B	5 1/2"		50
TB658BS	6 5/8" short		50
TB858BS	8 5/8" short		25

Available Powder Coated Black

**B-6 BRACE BANDS - BEVELED**  
**Hot Dipped Galvanized 12 Gauge x 59/64" Steel**

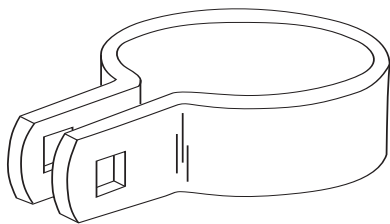

Part No.	Size	Weight	Carton Quantity
BB138B	1 3/8" OD	40 LBS	250
BB158B	1 5/8" OD	60 LBS	300
BB200B	2" OD	55 LBS	250
BB250B	2 1/2" OD	68 LBS	250
BB300B	3" OD	66 LBS	200
BB350B	3 1/2" OD	38 LBS	100
BB400B	4" OD	41 LBS	100
BB450B	4 1/2" OD	44 LBS	100
BB658B	6 5/8" OD	33 LBS	50
BB858B	8 5/8" OD	25 LBS	25
USE CARRIAGE BOLTS			
NB516125	5/16" x 1 1/4"	46 LBS	1000
Also available as special order:			
BB500B	5"		50
BB550B	5 1/2"		50

Available Powder Coated Black



**B-7 CORNER BRACE BANDS 90° - BEVELED**  
**Hot Dipped Galvanized 12 Gauge x 59/64" Steel**

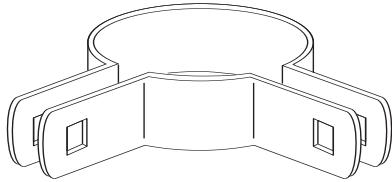

Part No.	Size	Weight	Carton Quantity
CBB200	2" OD	65 LBS	250
CBB250	2 1/2" OD	62 LBS	200
CBB300	3" OD	57 LBS	150
USE CARRIAGE BOLTS			
NB516125	5/16" x 1 1/4"	46 LBS	1000

Available Powder Coated Black

**B-10 TWO WAY BRACE BANDS 180° - BEVELED**  
**Hot Dipped Galvanized 12 Gauge x 59/64" Steel**

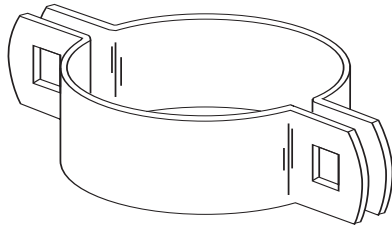

Part No.	Size	Weight	Carton Quantity
2WB200	2" OD	25 LBS	100
2WB250	2 1/2" OD	27 LBS	100
2WB300	3" OD	34 LBS	100
2WB400	4" OD	50 LBS	100
USE CARRIAGE BOLTS			
NB516125	5/16" x 1 1/4"	46 LBS	1000

Available Powder Coated Black

**THREE WAY BANDS - BEVELED**  
**Hot Dipped Galvanized 12 Gauge x 59/64" Steel**

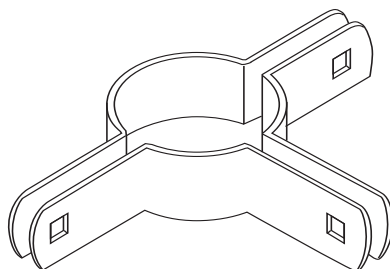

Part No.	Size	Weight	Carton Quantity
3WB250	2 1/2" OD	35 LBS	100
3WB300	3" OD	41 LBS	100

Available Powder Coated Black



**SQUARE TENSION BANDS**

Hot Dipped Galvanized 12 Gauge <sup>13</sup>/<sub>16</sub>" Steel

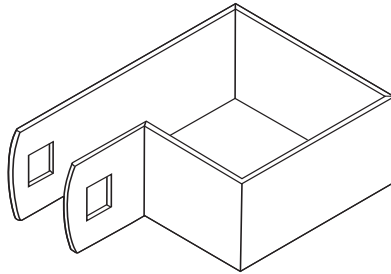

Part No.	Size	Weight	Carton Quantity
TBSQ20	2" OD	63 LBS	250
TBSQ25	2 1/2" OD	56 LBS	200
TBSQ30	3" OD	53 LBS	150
TBSQ40	4" OD	24 LBS	50
TBSQ60	6" OD	35 LBS	50

Also available in 5", 7" and 8" as Special Order

Available Powder Coated Black

**SQUARE BRACE BANDS**

Hot Dipped Galvanized 12 Gauge x <sup>59</sup>/<sub>64</sub>" Steel

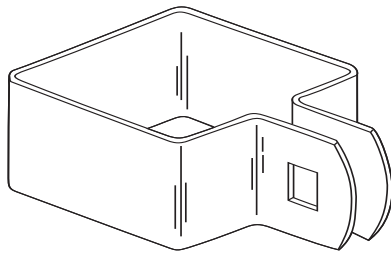

Part No.	Size	Weight	Carton Quantity
BBSQ20	2" OD	55 LBS	250
BBSQ25	2 1/2" OD	54 LBS	200
BBSQ30	3" OD	58 LBS	150
BBSQ40	4" OD	24 LBS	50
BBSQ60	6" OD	34 LBS	50

Also available in 5", 7" and 8" as Special Order

Available Powder Coated Black

**C POST AND H BEAM TENSION BANDS**

Hot Dipped Galvanized 12 Gauge x <sup>13</sup>/<sub>16</sub>" Steel

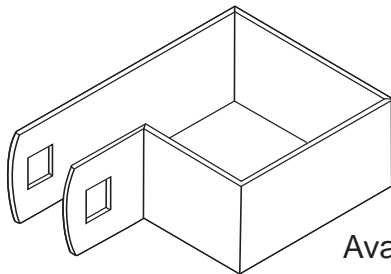

Part No.	Size	Weight	Carton Quantity
TBSSMC	SMALL C POST	55 LBS	250
TBLARC	LARGE C POST	59 LBS	250
TBSRH	SR H BEAM	63 LBS	250

Available Powder Coated Black

**C POST AND H BEAM BRACE BANDS**

Hot Dipped Galvanized 12 Gauge x <sup>59</sup>/<sub>64</sub>" Steel

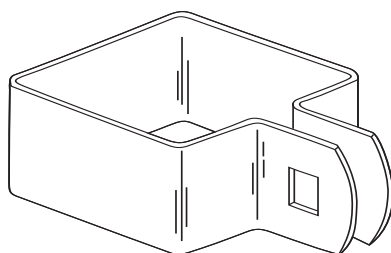

Part No.	Size	Weight	Carton Quantity
BBSMC	SMALL C POST	55 LBS	250
BBLAC	LARGE C POST	63 LBS	250
BBSRH	SR H BEAM	64 LBS	250

Available Powder Coated Black



**HEAVY TENSION BANDS**  
Hot Dipped Galvanized 1/8" x 1" Steel

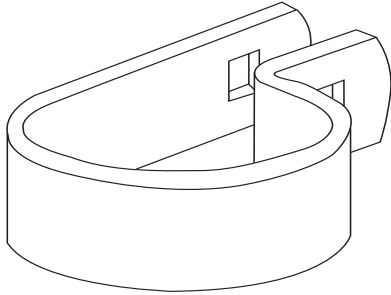

Part No.	Size	Weight	Carton Quantity
TBHE15	1 <sup>5</sup> / <sub>8</sub> " OD	60 LBS	200
TBHE20	2" OD	63 LBS	200
TBHE25	2 <sup>1</sup> / <sub>2</sub> " OD	41 LBS	100
TBHE30	3" OD	49 LBS	100
TBHE35	3 <sup>1</sup> / <sub>2</sub> " OD	55 LBS	100
TBHE40	4" OD	61 LBS	100
USE CARRIAGE BOLTS			
NB38150	3/8" x 1 <sup>1</sup> / <sub>2</sub> "	88 LBS	1000

Available Powder Coated Black

**HEAVY BRACE BANDS**  
Hot Dipped Galvanized 1/8" x 1" Steel

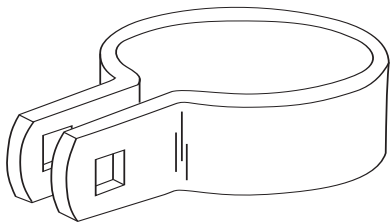

Part No.	Size	Weight	Carton Quantity
BBHE20	2" OD	57 LBS	200
BBHE25	2 <sup>1</sup> / <sub>2</sub> " OD	33 LBS	100
BBHE30	3" OD	41 LBS	100
BBHE35	3 <sup>1</sup> / <sub>2</sub> " OD	47 LBS	100
BBHE40	4" OD	52 LBS	100
USE CARRIAGE BOLTS			
NB38150	3/8" x 1 <sup>1</sup> / <sub>2</sub> "	88 LBS	1000

Available Powder Coated Black



**ALUMINUM FENCE TIES**

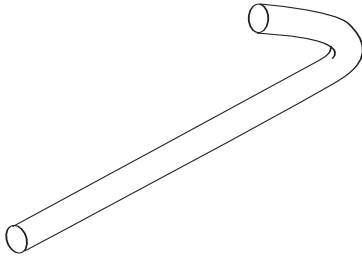

Part No.	Size	Length	Carton	
			Weight	Quantity
#12	9 GA	5 1/2"	42 LBS	4200
#13	9 GA	6 1/2"	47 LBS	3700
#16	9 GA	8 1/4"	48 LBS	3100
#23	6 GA	6 1/2"	39 LBS	1800
#26	6 GA	8 1/4"	48 LBS	1800
#33	11 GA	6 1/2"	50 LBS	5600

ALUMINUM WIRE COILS		
Size	Weight	Quantity
6 GA	35 LBS	29 FT/LB
9 GA	35 LBS	51.8 FT/LB
11 GA	35 LBS	72 FT/LB

ALUMINUM BLACK WIRE		
Size	Weight	Quantity
6 GA	35 LBS	40 FT/LB
9 GA	35 LBS	64 FT/LB

Available Vinyl Coated Black

**ALUMINUM HOG RINGS**

9 Gauge

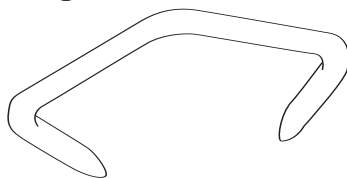

Part No.	Size	Approx Pieces/LB	Carton Weight
HOG9	9 GA	208	50 LBS

Available Vinyl Coated Black



**ALUMINUM DOME CAPS**

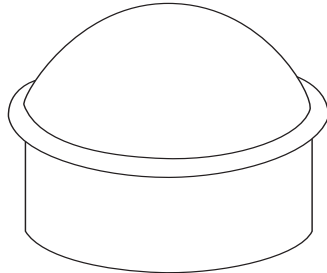

Part No.	Size	Weight	Bag Quantity
ADC138	1 <sup>3</sup> / <sub>8</sub> " OD	50 LBS	500
ADC158	1 <sup>5</sup> / <sub>8</sub> " OD	75 LBS	500
ADC200	2" OD	53 LBS	250
ADC250	2 <sup>1</sup> / <sub>2</sub> " OD	70 LBS	250
ADC300	3" OD	45 LBS	100
ADC400	4" OD	36 LBS	50
ADC658	6 <sup>5</sup> / <sub>8</sub> " OD	20 LBS	10

Available Vinyl Coated Black

**ALUMINUM ACORN POST CAP**

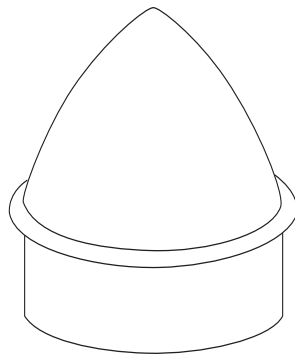

Part No.	Size	Weight	Bag Quantity
APC138	1 <sup>3</sup> / <sub>8</sub> " OD	45 LBS	350
APC158	1 <sup>5</sup> / <sub>8</sub> " OD	55 LBS	300
APC200	2" OD	60 LBS	250
APC250	2 <sup>1</sup> / <sub>2</sub> " OD	62 LBS	200
APC300	3" OD	46 LBS	100
APC400	4" OD	50 LBS	50
APC658	6 <sup>5</sup> / <sub>8</sub> " OD	10 LBS	10

Available Vinyl Coated Black

**PRESSED STEEL POST CAPS**

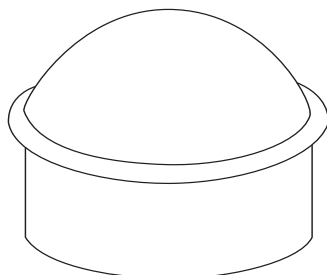

Part No.	Size	Weight	Carton Quantity
PSPC238	2 <sup>3</sup> / <sub>8</sub> " OD	28 LBS	100
PSPC278	2 <sup>7</sup> / <sub>8</sub> " OD	37 LBS	100
PSPC400	4" OD	41 LBS	100
PSPC658	6 <sup>5</sup> / <sub>8</sub> " OD	21 LBS	10

Available Vinyl Coated Black



**ALUMINUM LOOP CAPS**

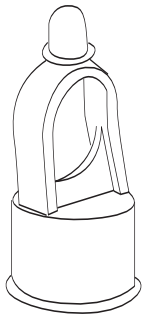

Part No.	Size	Weight	Bag Quantity
ALC158	1 <sup>5</sup> / <sub>8</sub> " x 1 <sup>3</sup> / <sub>8</sub> "	75 LBS	250
ALC213	2" x 1 <sup>3</sup> / <sub>8</sub> "	60 LBS	200
ALC215	2" x 1 <sup>5</sup> / <sub>8</sub> "	53 LBS	150
ALC255	2 <sup>1</sup> / <sub>2</sub> " x 1 <sup>5</sup> / <sub>8</sub> "	75 LBS	100

Available Vinyl Coated Black

**PRESSED STEEL LOOP CAPS**

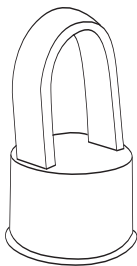

Part No.	Size	Weight	Carton Quantity
PSLC1513	1 <sup>5</sup> / <sub>8</sub> " x 1 <sup>3</sup> / <sub>8</sub> "	28 LBS	100
PSLC1515	1 <sup>5</sup> / <sub>8</sub> " x 1 <sup>5</sup> / <sub>8</sub> "	30 LBS	100
PSLC2138	2" x 1 <sup>3</sup> / <sub>8</sub> "	34 LBS	100
PSLC2158	2" x 1 <sup>5</sup> / <sub>8</sub> "	25 LBS	100
PSLC2358	2 <sup>1</sup> / <sub>2</sub> " x 1 <sup>5</sup> / <sub>8</sub> "	28 LBS	100

Available Vinyl Coated Black

**ALUMINUM OFFSET RAIL ENDS**

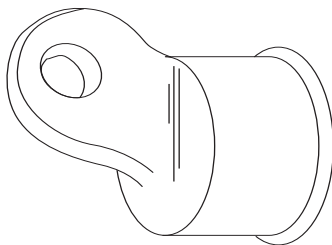

Part No.	Size	Weight	Bag Quantity
ARE138	1 <sup>3</sup> / <sub>8</sub> " OD	38 LBS	250
ARE158	1 <sup>5</sup> / <sub>8</sub> " OD	51 LBS	250

Available Vinyl Coated Black

**PRESSED STEEL OFFSET RAIL ENDS**

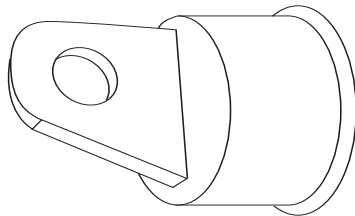

Part No.	Size	Weight	Bag Quantity
PSRE158	1 <sup>5</sup> / <sub>8</sub> " OD	47 LBS	100

Available Powder Coated Black

**DUCTILE IRON COMBINATION RAIL ENDS**

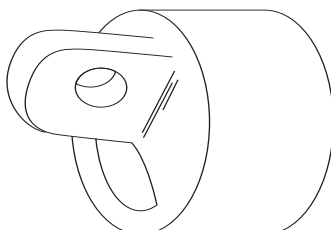

Part No.	Size	Weight	Bag Quantity
CRE158	1 <sup>5</sup> / <sub>8</sub> " OD	63 LBS	100

Available Powder Coated Black



**DUCTILE IRON BACKSTOP ANGLE**

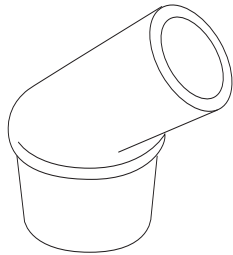

Part No.	Size	Weight	Bag Quantity
BAS	Fits 3" or 4" Post	35 LBS	10

**STEEL BARB ARM BLADES**

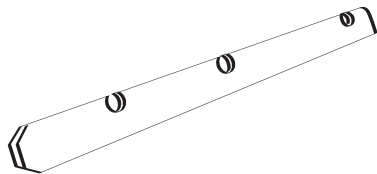

Part No.	Size	Weight	Bag Quantity
BAB	3 STRAND	50 LBS	50

**DUCTILE IRON CORNER BARB ARMS**

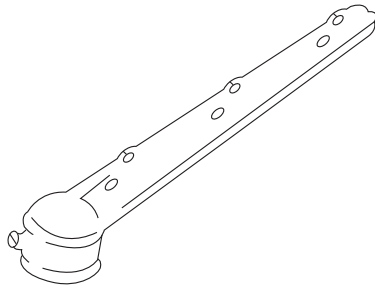

Part No.	Size	Weight	Bag Quantity
CBA250	2 1/2" OD	43 LBS	10
CBA300	3" OD	48 LBS	10
PRICES INCLUDE SET SCREW			

**ONE PIECE BARB ARMS**

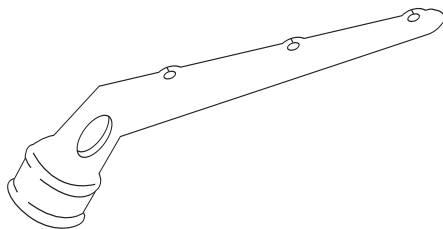

Part No.	Size	Weight	Bag Quantity
1PBA20	2" OD	17 LBS	10
1PBA25	2 1/2" OD	18 LBS	10

**BARB ARM BASES**

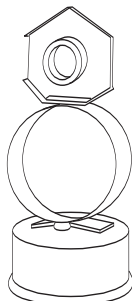

Part No.	Size	Weight	Bag Quantity
BAB2158	2" x 1 5/8"	32 LBS	25
BAB2558	2 1/2" x 1 5/8"	37 LBS	25



**TOP RAIL SLEEVES**

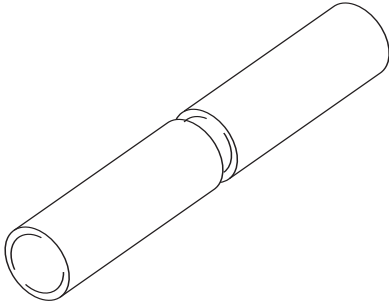

Part No.	Size	Weight	Bag Quantity
TRS138	1 3/8" OD	37 LBS	100
TRS158	1 5/8" OD	28 LBS	50

Available Powder Coated Black

**FRAME HINGE - MALLEABLE**  
Residential Female Hinge

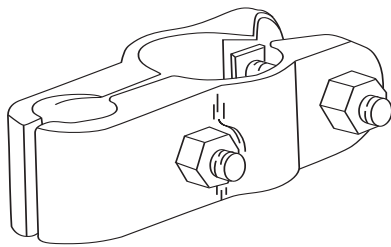

Part No.	Size	Weight	Bag Quantity
RFH138	1 3/8" OD	32 LBS	50
RFH158	1 5/8" OD	35 LBS	50
BOLTS INCLUDED			

**POST HINGE - MALLEABLE**  
Residential Post Hinge

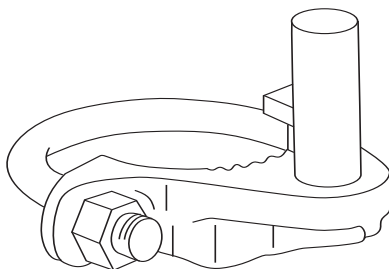

Part No.	Size	Weight	Bag Quantity
RPH200	2" OD	32 LBS	50
RPH250	2 1/2" OD	45 LBS	50
RPH300	3" OD	47 LBS	50
BOLTS INCLUDED			



**FEMALE GATE HINGES - PRESSED STEEL**  
Hot Dipped Galvanized

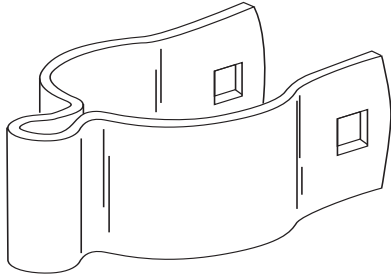

Part No.	Size	Carton	
		Weight	Quantity
FH138	1 <sup>3</sup> / <sub>8</sub> " OD	42 LBS	100
FH158	1 <sup>5</sup> / <sub>8</sub> " OD	46 LBS	100
FH200	2" OD	52 LBS	100
DOES NOT INCLUDE BOLTS			

Available Powder Coated Black

**MALE GATE HINGES - PRESSED STEEL**  
Hot Dipped Galvanized

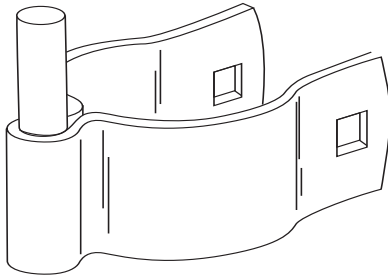

Part No.	Size	Carton	
		Weight	Quantity
MH138	1 <sup>3</sup> / <sub>8</sub> " OD	66 LBS	100
MH158	1 <sup>5</sup> / <sub>8</sub> " OD	68 LBS	100
MH200	2" OD	73 LBS	100
MH250	2 <sup>1</sup> / <sub>2</sub> " OD	39 LBS	50
MH300	3" OD	40 LBS	50
DOES NOT INCLUDE BOLTS			

Available Powder Coated Black

**FORK LATCHES - PRESSED STEEL**  
Hot Dipped Galvanized

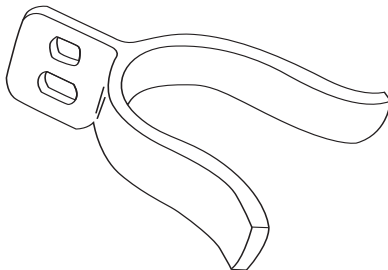

Part No.	Size	Carton	
		Weight	Quantity
FL138	1 <sup>3</sup> / <sub>8</sub> " OD	39 LBS	100
FL200	2" OD	46 LBS	100
FL250	2 <sup>1</sup> / <sub>2</sub> " OD	48 LBS	100
FL300	3" OD	62 LBS	100
DOES NOT INCLUDE BOLTS			

Available Powder Coated Black



**FRAME CLAMPS - PRESSED STEEL**

Hot Dipped Galvanized

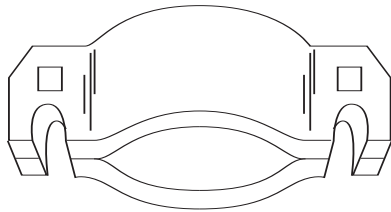

Part No.	Size	Weight	Carton Quantity
FC138	1 <sup>3</sup> / <sub>8</sub> " OD	41 LBS	100
FC158	1 <sup>5</sup> / <sub>8</sub> " OD	46 LBS	100
FC200	2" OD	62 LBS	100

DOES NOT INCLUDE BOLTS

Available Powder Coated Black

**GATE SCROLLS - THREE PIECE**

Hot Dipped Galvanized 12 Gauge x 3/4" Steel

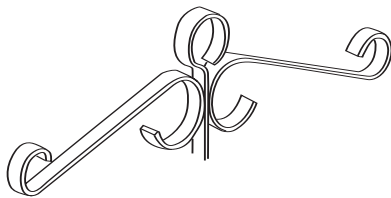

Part No.	Size	Weight	Bag Quantity
3PGS18	18" OD	10 LBS	10
3PGS24	24" OD	12 LBS	10

DOES NOT INCLUDE BOLTS

**GATE TRUSS ROD TIGHTENERS**

Standard Industrial - 1/4" x 4<sup>3</sup>/<sub>4</sub>"

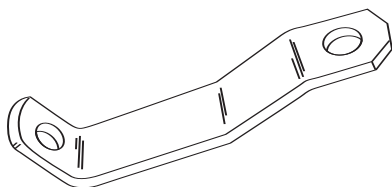

Part No.	Weight	Bag Quantity
TRT	35 LBS	100

DOES NOT INCLUDE BOLTS



**CANTILEVER GATE ROLLERS - DUCTILE IRON**  
**Hot Dipped Galvanized - Five Year Warranty**

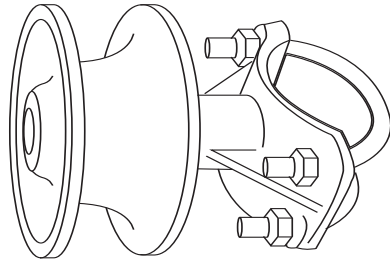

Note: Hampden Fence Supply, Inc. will not be held liable for cantilever gate rollers installed without **roller guards**.

Part No.	Size	Carton Weight	Carton Quantity
CR300	3" x 2 1/2"	73 LBS	4
CR400	4" x 2 1/2"	78 LBS	4
CR658	6 5/8" x 2 1/2"	44 LBS	2
ALL ROLLERS EQUIPPED WITH GREASE FITTINGS			

**POLYMER CANTILEVER GATE ROLLERS - WITH GUARDS**

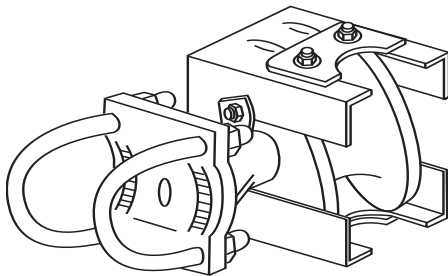

Part No.	Size	Carton Weight	Carton Quantity
PCR400	4" x 2 1/2"	34 LBS	2

**LATCH ASSEMBLY FOR CANTILEVER GATE ROLLERS**

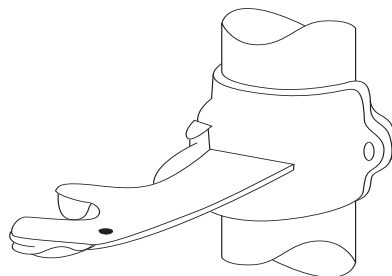

Part No.	Size	Carton Weight	Carton Quantity
CL300	3"	28 LBS	4
CL400	4"	30 LBS	4



**CANTILEVER ROLLER GUARDS**

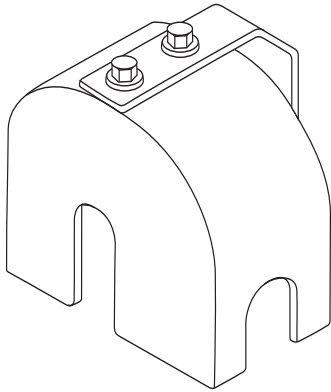

Made of 16 gauge hot dipped galvanized steel. It is designed to fit either round or square gate posts. Cover fits all standard 3", 4" and 6<sup>5</sup>/<sub>8</sub>" cantilever rollers. It covers the rollers completely while leaving access to grease fitting. Improves the look of the finished product.

Used only on top - Bottom is optional.

Part No.	Size	Weight	Bag Quantity
20CRT400	Fits 3", 4", 6 <sup>5</sup> / <sub>8</sub> "	7 LBS	1

**RESIDENTIAL LOCKING DEVICE**

For 1<sup>3</sup>/<sub>8</sub>" Gate Frame

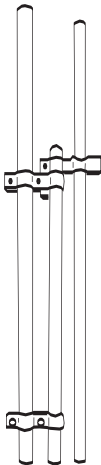

Fork 1" x 8 ga. Steel  
 Guides 1" x 8 ga. Steel  
 Drop Rod 7/8" OD Pipe

- Positive Locking
- Easy to Install
- Install after Frame is Welded

Part No.		Weight	Qty.
RLDCOM	DROP ROD W/ GUIDES	4 LBS	EA
RLDGUI	RLD GUIDE ONLY	27 LBS	50/Bag
RLDROD	ROD ONLY	3.2 LBS	EA

**INDUSTRIAL LOCKING DEVICES**

Hot Dipped Galvanized Steel

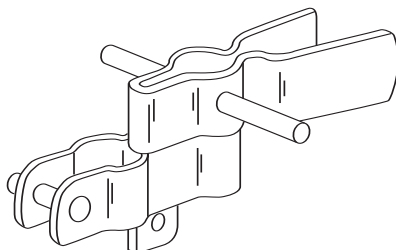

Fits 2" Gate Frames.  
 Two Combinations to choose from.  
 Price Does Not include Pipe,  
 Includes 3/8" x 3" Nuts and Bolts.

Part No.		Weight	Carton Quantity
ILD1	2 GUIDES	4 <sup>3</sup> / <sub>4</sub> LBS	EA
ILD2	3 GUIDES	6 LBS	EA

No Holes to Drill. Install after Frame is Made.  
 Allow 4<sup>1</sup>/<sub>2</sub>" Clearance for these Locks.



**MALLEABLE INDUSTRIAL BOX HINGE COMPLETE**  
**Ball And Socket Type - Fits Both 1<sup>5</sup>/<sub>8</sub>" And 2" Gate Frame**

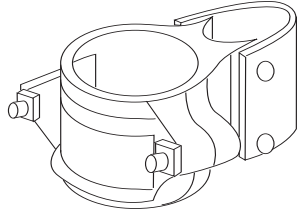

Part No.	Size	Weight	Bag Quantity
IH250	2 <sup>1</sup> / <sub>2</sub> "	20 LBS	4
IH300	3"	21 LBS	4
IH400	4"	26 LBS	4
IH658	6 <sup>5</sup> / <sub>8</sub> "	28 LBS	2
IH858	8 <sup>5</sup> / <sub>8</sub> "	34 LBS	2

**MALLEABLE INDUSTRIAL BOX HINGE ATTACHMENT - 180°**

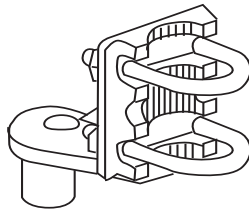

Part No.	Size	Weight	Bag Quantity
180ADA	1 <sup>5</sup> / <sub>8</sub> " x 2"	5 LBS	10

Available Powder Coated Black

**BULL DOG HINGE - PRESSED STEEL**

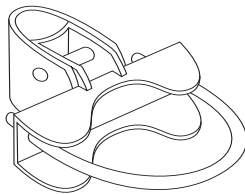

Part No.	Size	Weight	Bag Quantity
BDH250	2 <sup>1</sup> / <sub>2</sub> "	41 LBS	12
BDH300	3"	42 LBS	12
BDH400	4"	45 LBS	12

**MALLEABLE INDUSTRIAL OFFSET HINGES**  
**Fits Both 1<sup>5</sup>/<sub>8</sub>" & 2" Gate Frame**

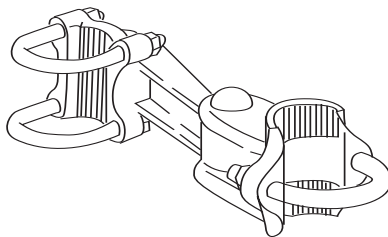

Part No.	Size	Weight	Bag Quantity
IOH238	2 <sup>1</sup> / <sub>2</sub> "	18 LBS	4
IOH300	3"	19 LBS	4
IOH400	4"	23 LBS	4
IOH658	6 <sup>5</sup> / <sub>8</sub> "	21 LBS	2

Available Powder Coated Black

**DUCKBILL GATE HOLDBACKS**  
**Ductile Iron**

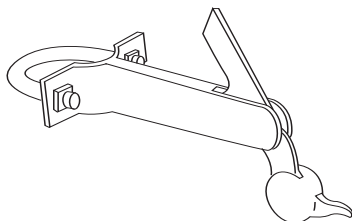

Part No.	Weight	Bag Quantity
DUCKHB	21 LBS	10
PRICE INCLUDES U-BOLT & 5/16" x 1 <sup>1</sup> / <sub>2</sub> " BOLTS		



**KENNEL CLAMPS**

Hot Dipped Galvanized 13 Gauge x 1 1/2" Steel

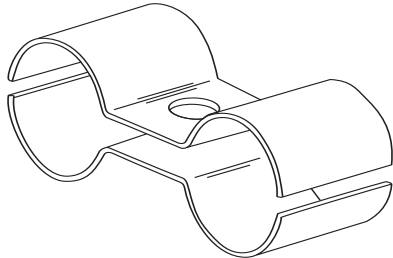

Part No.	Size	Weight	Carton Quantity
KENCLA	1 3/8" x 1 3/8"	54 LBS	125
USE CARRIAGE BOLTS			
NB516125	5/16" x 1 1/4"	46 LBS	1000
Also Available in 12 Gauge as Special Order: KENCLA12G 1 3/8" x 1 3/8"			

Available Powder Coated Black

**SADDLE CLAMPS**

Hot Dipped Galvanized 8 Gauge x 1 1/4" Steel

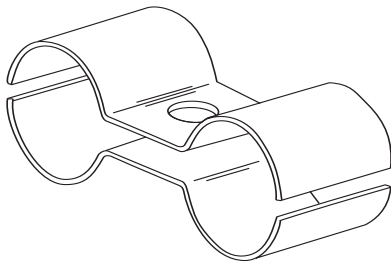

Part No.	Size	Weight	Carton Quantity
SC1515	1 5/8" x 1 5/8"	68 LBS	100
USE CARRIAGE BOLTS			
NB38150	3/8" x 1 1/2"	88 LBS	1000

Available Powder Coated Black

**KENNEL BANDS**

Hot Dipped Galvanized 14 Gauge x 3/4" Steel

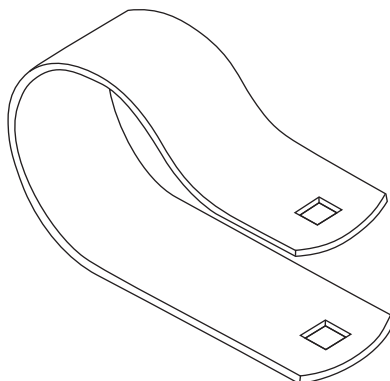

Part No.	Size	Weight	Carton Quantity
KENBAN	1 3/8" OD	71 LBS	500
USE CARRIAGE BOLTS			
NB516125	5/16" x 1 1/4"	46 LBS	1000

Available Powder Coated Black



**END RAIL CLAMPS**  
Hot Dipped Galvanized 13 Gauge Steel

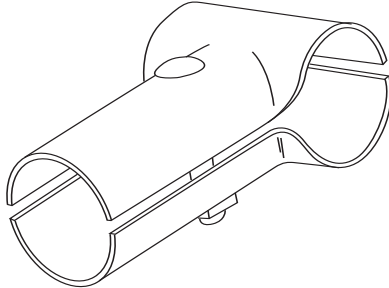

Part No.	Size	Weight	Carton Quantity
EC1313	1 <sup>3</sup> / <sub>8</sub> " x 1 <sup>3</sup> / <sub>8</sub> "	40 LBS	100
EC2138	2" x 1 <sup>3</sup> / <sub>8</sub> "	50 LBS	100
USE CARRIAGE BOLTS			
NB516250	5 <sup>1</sup> / <sub>16</sub> " x 2 <sup>1</sup> / <sub>2</sub> "	70 LBS	1000
EC1515	1 <sup>5</sup> / <sub>8</sub> " x 1 <sup>5</sup> / <sub>8</sub> "	55 LBS	100
EC2158	2" x 1 <sup>5</sup> / <sub>8</sub> "	55 LBS	100
EC2558	2 <sup>1</sup> / <sub>2</sub> " x 1 <sup>5</sup> / <sub>8</sub> "	34 LBS	50
EC3158	3" x 1 <sup>5</sup> / <sub>8</sub> "	37 LBS	50
EC3558	3 <sup>1</sup> / <sub>2</sub> " x 1 <sup>5</sup> / <sub>8</sub> "	40 LBS	50
EC4158	4" x 1 <sup>5</sup> / <sub>8</sub> "	42 LBS	50
USE CARRIAGE BOLTS			
NB38250	3 <sup>3</sup> / <sub>8</sub> " x 2 <sup>1</sup> / <sub>2</sub> "	98 LBS	1000
Also Available in 12 Gauge as Special Order:			
EC1313	1 <sup>3</sup> / <sub>8</sub> " x 1 <sup>3</sup> / <sub>8</sub> "		100

Available Powder Coated Black

**LINE RAIL CLAMPS**  
Hot Dipped Galvanized 13 Gauge Steel

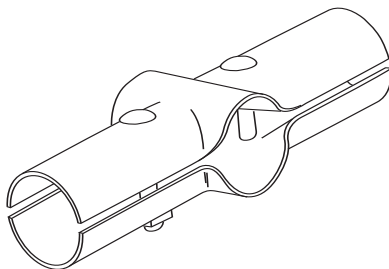

Part No.	Size	Weight	Carton Quantity
LC1313	1 <sup>3</sup> / <sub>8</sub> " x 1 <sup>3</sup> / <sub>8</sub> "	60 LBS	100
LC1513	1 <sup>5</sup> / <sub>8</sub> " x 1 <sup>3</sup> / <sub>8</sub> "	60 LBS	100
LC2138	2" x 1 <sup>3</sup> / <sub>8</sub> "	37 LBS	50
USE CARRIAGE BOLTS			
NB516250	5 <sup>1</sup> / <sub>16</sub> " x 2 <sup>1</sup> / <sub>2</sub> "	70 LBS	1000
LC1515	1 <sup>5</sup> / <sub>8</sub> " x 1 <sup>5</sup> / <sub>8</sub> "	38 LBS	50
LC2158	2" x 1 <sup>5</sup> / <sub>8</sub> "	40 LBS	50
LC2558	2 <sup>1</sup> / <sub>2</sub> " x 1 <sup>5</sup> / <sub>8</sub> "	50 LBS	50
LC3158	3" x 1 <sup>5</sup> / <sub>8</sub> "	60 LBS	50
LC3558	3 <sup>1</sup> / <sub>2</sub> " x 1 <sup>5</sup> / <sub>8</sub> "	65 LBS	50
LC4158	4" x 1 <sup>5</sup> / <sub>8</sub> "	70 LBS	50
LCLAC	LRG C x 1 <sup>5</sup> / <sub>8</sub> "	50 LBS	50
LCSRH	SRH x 1 <sup>5</sup> / <sub>8</sub> "	50 LBS	50
USE CARRIAGE BOLTS			
NB38250	3 <sup>3</sup> / <sub>8</sub> " x 2 <sup>1</sup> / <sub>2</sub> "	98 LBS	1000

Available Powder Coated Black



**CARRIAGE BOLTS AND NUTS**  
Hot Dipped Galvanized

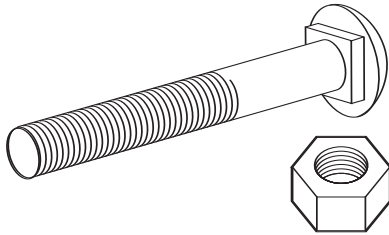

Part No.	Size	Carton	
		Weight	Quantity
NB516125	5/16" x 1 1/4"	46 LBS	1000
NB516150	5/16" x 1 1/2"	48 LBS	1000
NB516175	5/16" x 1 3/4"	50 LBS	1000
NB516200	5/16" x 2"	60 LBS	1000
NB516250	5/16" x 2 1/2"	70 LBS	1000
NB516300	5/16" x 3"	72 LBS	1000
NB516350	5/16" x 3 1/2"	74 LBS	1000
NB516400	5/16" x 4"	76 LBS	1000
NB516450	5/16" x 4 1/2"	78 LBS	1000
NB38150	3/8" x 1 1/2"	88 LBS	1000
NB38200	3/8" x 2"	90 LBS	1000
NB38250	3/8" x 2 1/2"	98 LBS	1000
NB38300	3/8" x 3"	105 LBS	1000
NB38350	3/8" x 3 1/2"	65 LBS	500
NB38400	3/8" x 4"	70 LBS	500
NB38450	3/8" x 4 1/2"	80 LBS	500

MINIMUM ORDER OF 100 PIECES

**TENSION BARS**  
Hot Dipped Galvanized

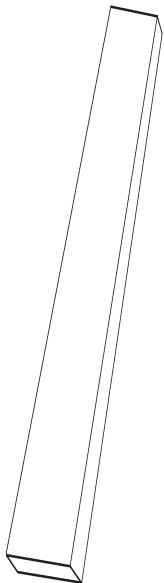

**3/16" x 5/8" Steel Bars**

Part No.	Size	Carton	
		Weight	Quantity
BAR540	47"	39 LBS	25
BAR550	59"	49 LBS	25
BAR560	71"	60 LBS	25

Available in Black Fiberglass or  
Black Powder Coated Steel

**3/16" x 3/4" Steel Bars**

Part No.	Size	Carton	
		Weight	Quantity
BAR360 *	71"	68 LBS	25
BAR370	83"	80 LBS	25
BAR380	95"	91 LBS	25
BAR310	119"	114 LBS	25
BAR312	144"	137 LBS	25

\*Available Powder Coated Black



**HEAVY DUTY FULCRUM LATCH**  
Hot Dipped Galvanized

**DOUBLE LATCH**

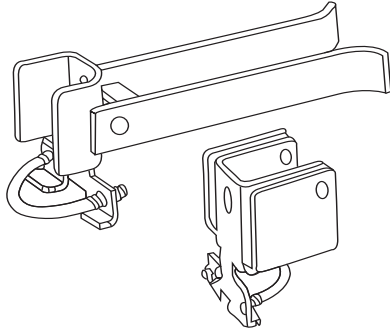

66RL1717

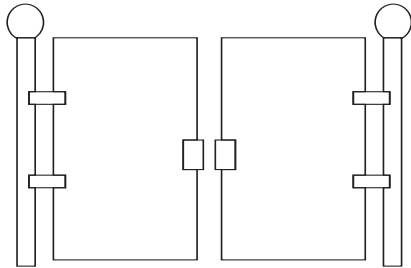

**SINGLE LATCH**

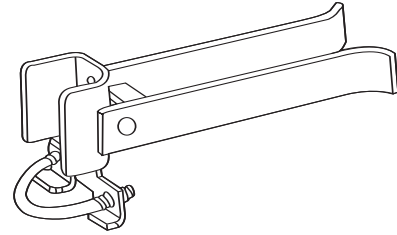

66RL1727  
66RL1740

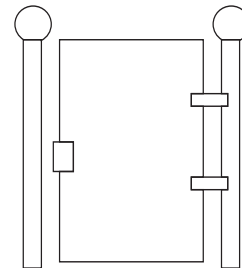

Part No.	Size	Description	Carton Weight	Carton Quantity
66RL1717	1 7/8" x 1 7/8"	FITS 1 5/8" - 1 7/8" FRAME ADJ. 2"-6" GAP	50 LBS	6
66RL1727	1 7/8" x 3"	FITS 1 5/8" - 1 7/8" FRAME FITS 3" POST ALLOWS 2"-4" GAP	42 LBS	8
66RL1740	1 7/8" x 4"	FITS 1 5/8" - 1 7/8" FRAME FITS 4" POST ALLOWS 2"-4" GAP	5.6 LBS	EA or 10/CASE

Available Powder Coated Black



**FLOOR FLANGES**

1/4" Thick

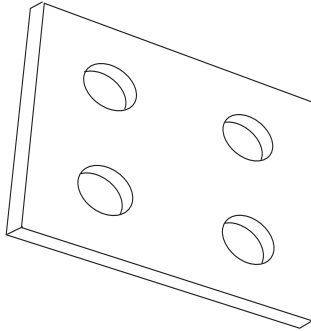

Part No.	Size	Carton/Bag Weight	Quantity
17FF3X6	3" x 6"	27 LBS	25
17FF4X4	4" x 4"	26 LBS	25
17FF5X5	5" x 5"	41 LBS	25
17FF6X6	6" x 6"	59 LBS	25
17FF8X8	8" x 8"	63 LBS	10

**MAASDAM'S UTICA-STYLE FENCE PLIERS**

Extended Nose Allows Greater Reach

High Quality

Smooth Working Action



ROUND NOSE			
Part No.	Size	Weight	Quantity
63109-10	10"	1 1/4 LBS	EA

**STEEL PIPE CLAMPS - WOOD TO STEEL ADAPTORS**

Hot Dipped Galvanized 12 Gauge x 59/64" Steel

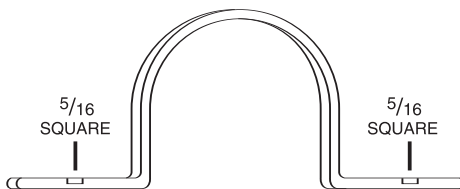

Part No.	Size	Carton Weight	Quantity
WSA158	1 5/8" OD	21 LBS	100
WSA178	1 7/8" OD	22 LBS	100
WSA250	2 1/2" OD	26 LBS	100
WSA300	3" OD	27 LBS	100
WSA400	4" OD	37 LBS	100

Available Powder Coated Black



**RESIDENTIAL & COMMERCIAL DRIVE ANCHOR UNIT**

8ga. x 1 1/4" Pressed Steel

Fits Posts Up To 3 1/2", JRH Beam, Small C Post and Square Post

Hot Dipped Galvanized Steel - Available with 5/16" or 3/8" hole

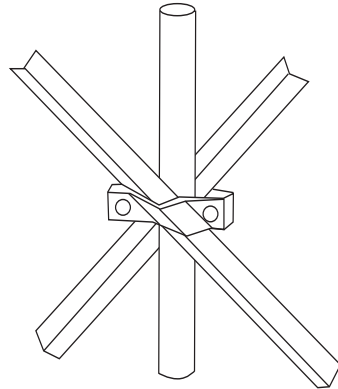

**COMPLETE UNIT INCLUDES:**

2 Anchor Blades 1" x 1" x 1/8" x 24"	1.65 LBS EA
1 Shoe (Carton Qty. 50 pc)	0.75 LBS EA
2 Nuts and Bolts for Round Post 5/16"	
For length of bolt add 1" to size of pipe.	

**RDA COMPLETE UNIT Part No.**

**Carton/Bundle Weight Quantity**

RDASHO	1 SET PER UNIT	38 LBS	50
RDABLA	2 BLADES/UNIT	43 LBS	25

USES 2 CARRIAGE BOLTS EACH

**INDUSTRIAL DRIVE ANCHOR UNIT**

Fits Up To 3 1/2" OD Post, SRH Beam, Large C Post and Square Post

Hot Dipped Galvanized Steel 8 ga. x 1 1/4" Pressed Steel

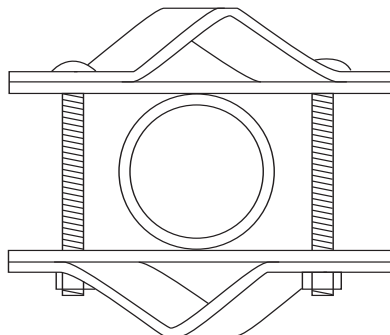

- REQUIRES** 2 - 1 1/4" x 1 1/4" x 1/8" x 30" Anchor Blades
- REQUIRES** 2 - Nuts + Bolts
- REQUIRES** 1 - Shoe

**Part No.**

**Carton/Bundle Weight Quantity**

IDACOM	4.25 LBS		EA
IDABLA	1 1/4" x 1 1/4" x 1/8" x 30"	68 LBS	25
IDASHO	3/8" hole	65 LBS	50

**RECOMMENDED BOLT LENGTH**

**Square Post**

- 2" Post - Use 3/8" x 4" Bolt
- 2 1/2" Post - Use 3/8" x 4 1/2" Bolt
- 3" Post - Use 3/8" x 5" Bolt
- 3 1/2" Post - Use 3/8" x 5 1/2" Bolt

**Round Post**

- 1 1/2" Post - Use 3/8" x 3" Bolt
- 2" Post - Use 3/8" x 3 1/2" Bolt
- 2 1/2" Post - Use 3/8" x 4" Bolt
- 3" Post - Use 3/8" x 4 1/2" Bolt
- 3 1/2" Post - Use 3/8" x 5" Bolt
- SRH Post - Use 3/8" x 4" Bolt
- Heavy/Large C Post - Use 3/8" x 4" Bolt



**WELDED WIRE HIGH SECURITY FENCE HARDWARE - 10 Gauge**

High security fence panels are attached to line posts, terminal posts and gate frames with 1/8" x 1" hot dip galvanized post brackets.

MINIMUM ORDER 2,000 SETS PER SIZE, 4-6 WEEKS DELIVERY

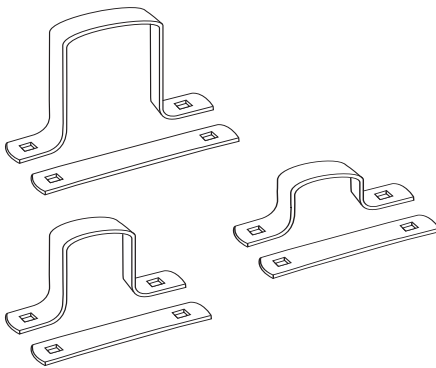

<b>C POST BRACKET</b>			
<b>Part No.</b>	<b>Size</b>	<b>Weight</b>	<b>Quantity</b>
HFSFC1625	1 <sup>5</sup> / <sub>8</sub> " x 1 <sup>1</sup> / <sub>4</sub> "	48 LBS	100
HFSFC1700	1 <sup>7</sup> / <sub>10</sub> " x 2 <sup>1</sup> / <sub>4</sub> "	53 LBS	100
HFSFC2500	2 <sup>1</sup> / <sub>2</sub> " x 3 <sup>1</sup> / <sub>4</sub> "	62 LBS	100
USE CARRIAGE BOLTS (2/Set)			
NB516125	5/16" x 1 <sup>1</sup> / <sub>4</sub> "	46 LBS	1000

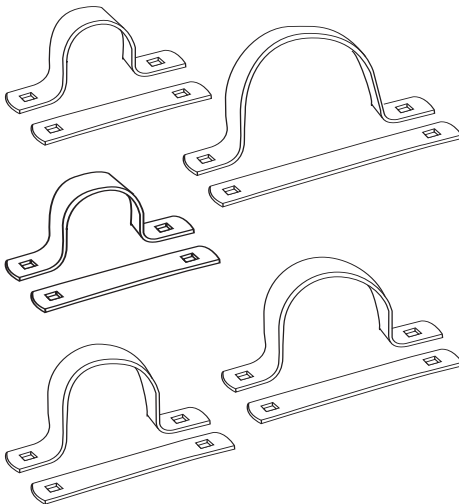

<b>ROUND POST BRACKET</b>			
<b>Part No.</b>	<b>Size</b>	<b>Weight</b>	<b>Quantity</b>
HFSF1660	1 <sup>2</sup> / <sub>3</sub> "	43 LBS	100
HFSF1875	1 <sup>7</sup> / <sub>8</sub> "	47 LBS	100
HFSF2375	2 <sup>3</sup> / <sub>8</sub> "	52 LBS	100
HFSF2875	2 <sup>7</sup> / <sub>8</sub> "	57 LBS	100
HFSF4000	4"	72 LBS	100
USE CARRIAGE BOLTS (2/Set)			
NB516125	5/16" x 1 <sup>1</sup> / <sub>4</sub> "	46 LBS	1000
Special Order:			
HFSF5563	5 <sup>9</sup> / <sub>16</sub> "	48 LBS	50
HFSF6625	6 <sup>5</sup> / <sub>8</sub> "	54 LBS	50
SUPERCLRC		66 LBS	50

Available Powder Coated Black



**HEAVY END RAIL CLAMPS**  
Hot Dipped Galvanized 3/16" Steel

Used by N.Y.C. Parks Dept, N.Y.C. School Construction Authority, Board of Education, N.Y. D.O.T.

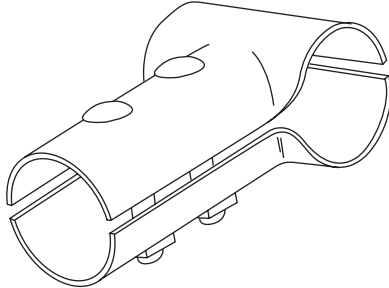

Part No.	Size	Carton	
		Weight	Quantity
ECHE2158	2" X 1 5/8"	31LBS	25
ECHE2558	2 1/2" X 1 5/8"	38LBS	25
ECHE3158	3" X 1 5/8"	42LBS	25
ECHE3558	3 1/2" X 1 5/8"	48LBS	25
ECHE4158	4" X 1 5/8"	53LBS	25
USE CARRIAGE BOLTS			
NB38250	3/8" X 2 1/2"	98LBS	1000

Corner Clamps Available. 20pc../Ctn.

Available Powder Coated Black

**HEAVY LINE RAIL CLAMPS**  
Hot Dipped Galvanized 3/16" Steel

Used by N.Y.C. Parks Dept, N.Y.C. School Construction Authority, Board of Education, N.Y. D.O.T.

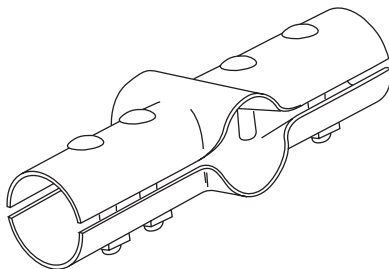

Part No.	Size	Carton	
		Weight	Quantity
LCHE2158	2" X 1 5/8"	43LBS	25
LCHE2558	2 1/2" X 1 5/8"	51LBS	25
LCHE3158	3" X 1 5/8"	54LBS	25
LCHE3558	3 1/2" X 1 5/8"	60LBS	25
LCHE4158	4" X 1 5/8"	65LBS	25
USE CARRIAGE BOLTS			
NB38250	3/8" X 2 1/2"	98LBS	25

Corner Clamps Available. 20pc../Ctn.

Available Powder Coated Black